

SPECIFICATIONS

- Frequency: DC – 18 GHz
- Power: 1 W
- VSWR: 1.35 max
- Impedance: $50\Omega \pm 5\%$
- TCR: $\pm 100\text{ppm}/^\circ\text{C}$
- Temperature: -55°C to 150°C
- Lead-Free, RoHS compliant

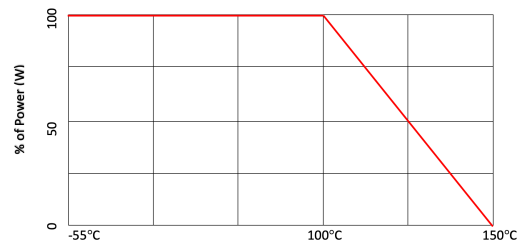

MECHANICAL OUTLINE

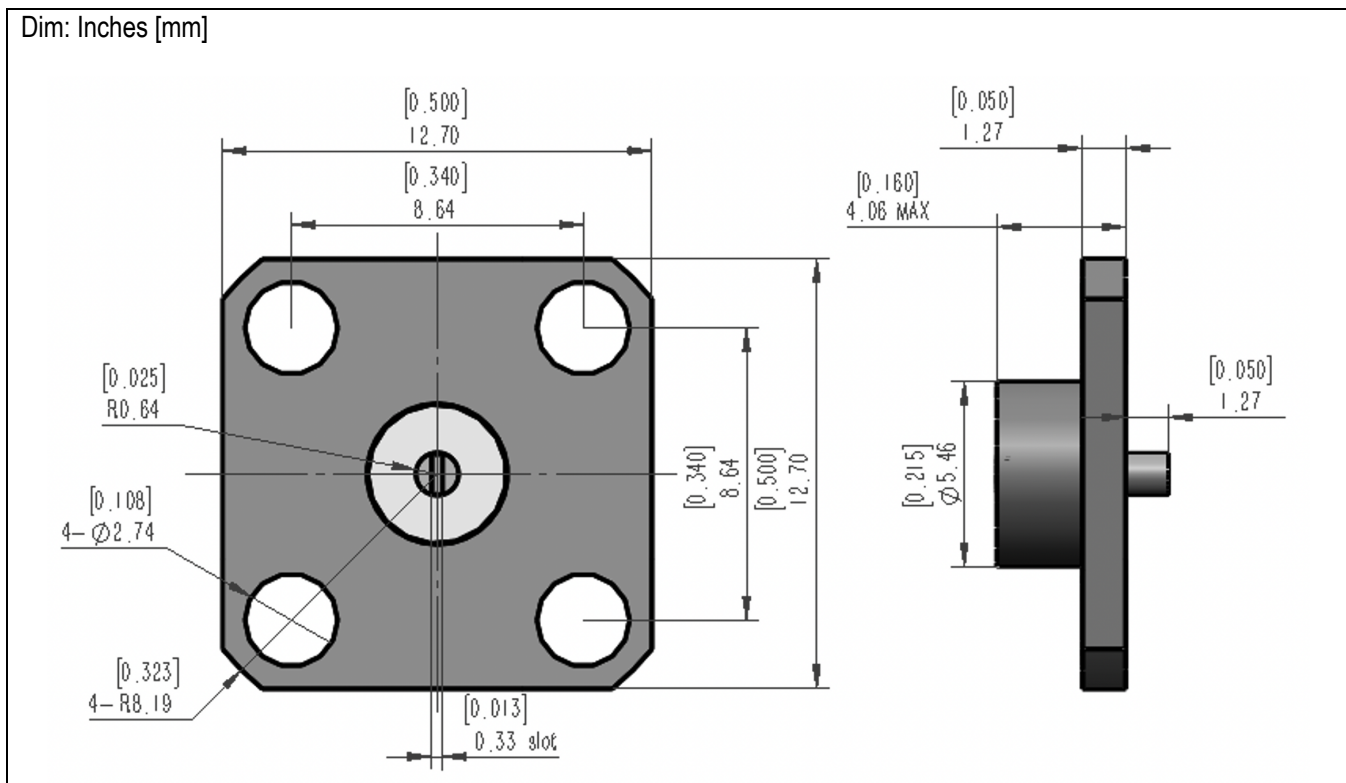

Tolerance: ± 0.01 inches [$\pm 0.25\text{mm}$]