

Q10HK-900R

SURFACE MOUNT 10dB DIRECTIONAL COUPLER

REV 1.0.0



APPLICATIONS

- Signal sampling
- Signal injection
- Source leveling
- Signal isolation
- Power monitoring
- Reflection measurement

FEATURES

- 800 - 1000 MHz
- High power
- Very low loss
- High directivity
- Flat coupling
- Compact and low profile
- Dimensionally stable materials for best CTE match
- Lead-Free, RoHS compliant

SPECIFICATIONS

TABLE 1: TYPICAL SPECIFICATIONS*

FREQ (MHz)	POWER (W)	PART NUMBER	INSERTION LOSS (dB)	COUPLING (dB)	DIRECTIVITY (dB)	VSWR	OPERATING TEMP (°C)	ΘJC (°C/W)
800-1000	80	Q10HK-900R	0.4	10 ± 0.5	16	1.4	-55 to +95	

* Units tested with small signal using Electro-Photonics test board at 25°C. Specifications subject to change without notice.

† Please consult sales (sales@electro-photonics.com) for custom footprints, sizes, and/or specifications.

MECHANICAL OUTLINE

* Dimensions are inches.

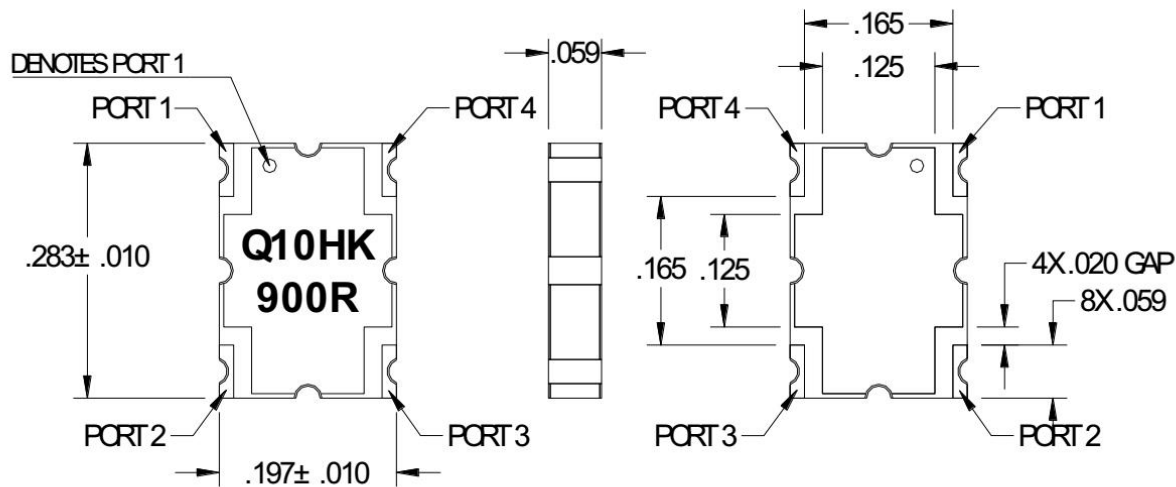

Q10HK-900R

SURFACE MOUNT 10dB DIRECTIONAL COUPLER

REV 1.0.0

TYPICAL PERFORMANCE

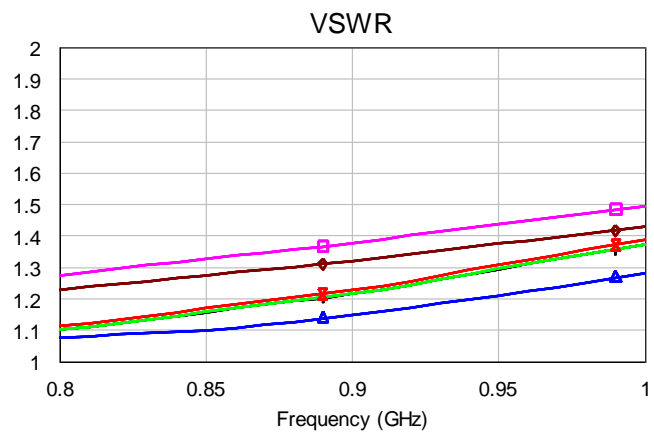
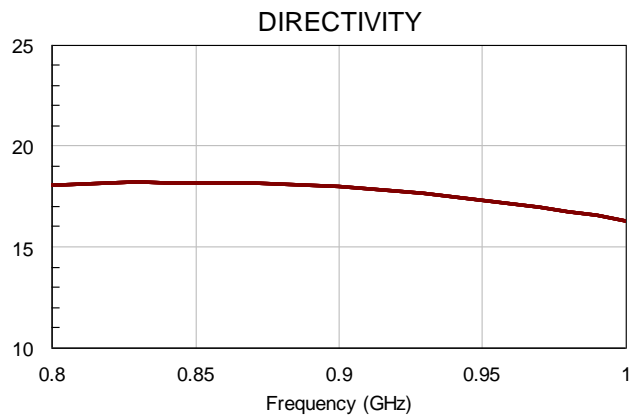
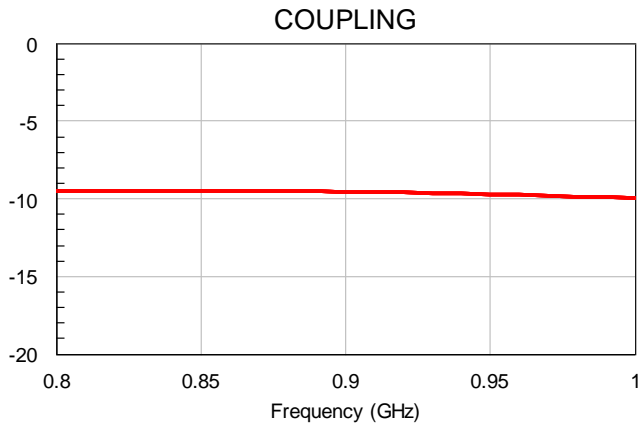

POWER DERATING

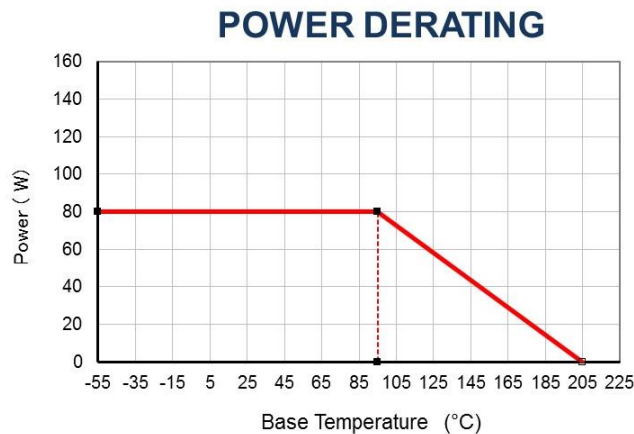

Q10HK-900R

SURFACE MOUNT 10dB DIRECTIONAL COUPLER

REV 1.0.0

PIN CONFIGURATION

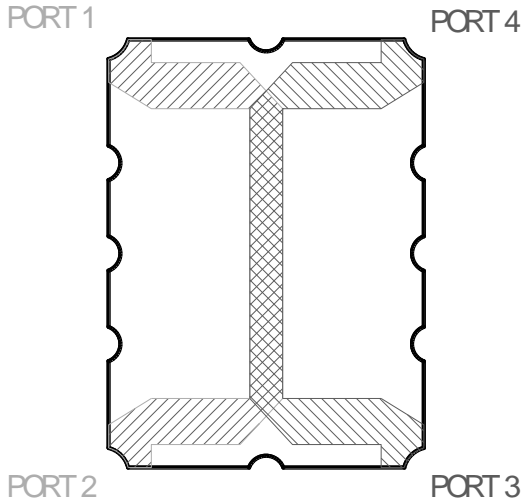

PORT 1	PORT 2	PORT 3	PORT 4
IN	DIRECT	ISOLATED	COUPLED
DIRECT	IN	COUPLED	ISOLATED
ISOLATED	COUPLED	IN	DIRECT
COUPLED	ISOLATED	DIRECT	IN

MOUNTING FOOTPRINT

Electro-Photonics test board is designed using 30 mil RO4350B material. Land pattern design must be taken into consideration when using a different thickness and/or dielectric constant in order to achieve optimal performance.

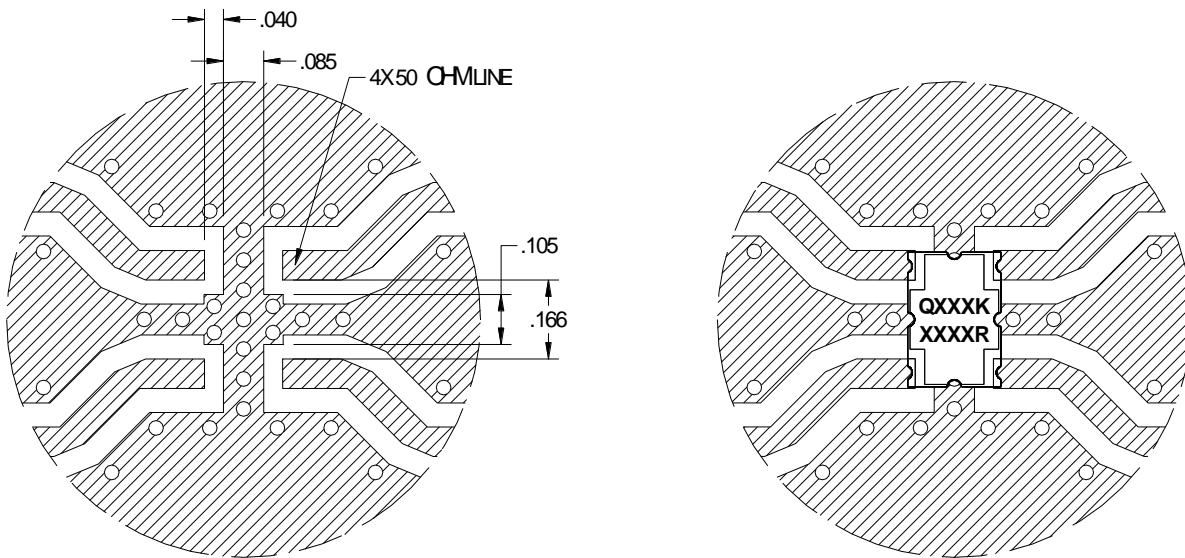

Q10HK-900R

SURFACE MOUNT 10dB DIRECTIONAL COUPLER

REV 1.0.0

ORDERING INFO*

* Consult sales (sales@electro-photonics.com) for custom configuration, size, footprint, and/or specifications. Tape & Reel available upon request (with minimum order quantities).

Q 1 0 H K - 9 0 0 R
① ② ③ ④

①	②	③	④
PRODUCT CODE	SIZE	FREQUENCY	PLATING
10dB DIRECTIONAL COUPLER	A = .250 X .200 K = .283 X .197 B = .560 X .200 G = .560 X .350 D = .650 X .480	MHz (SEE TABLE 1)	R = IMMERSION TIN E = ENIG (Electroless nickel immersion gold)



The Q10HK-900R is lead free, RoHS compliant product.